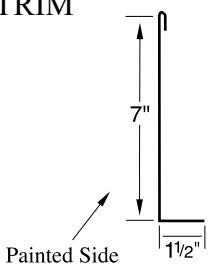
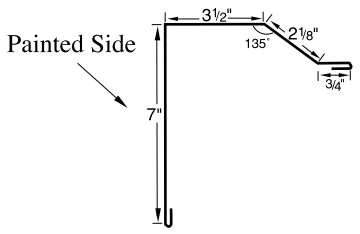
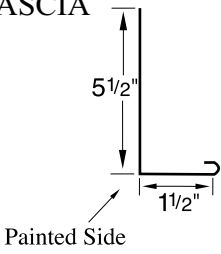
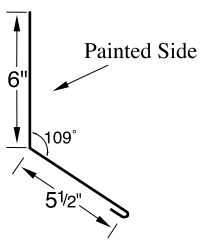
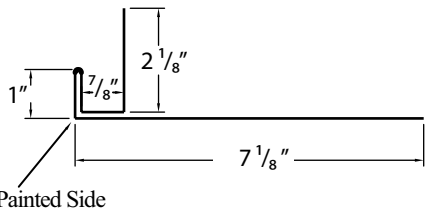

MICHIGAN CITY REGIONAL TRIMS

	Part Number	Length	Girth
<p>POST TRIM</p> 	SA(color)7	10'2"	8.5"
<p>TRACK DOOR JAMB</p> 	TDJT10(color) TDJT16(color)	10'2" 16'2"	14.375"
<p>SOFFIT FASCIA</p> 	SAF(color)512	10'2"	7.5"
<p>ENDWALL FLASHING</p> 	EFF(color)	10'2"	11.5"
<p>OVERHEAD DOOR JAMB</p> 	OHDJ	10'2"	12"

TRIMS

	Part Number	Length	Girth
RIDGECAP 	RCP(color)	10'6" Recommended 6:12 or less	13.75"
	RC2(color)	10'2" Recommended 7:12 or greater	
RESIDENTIAL RIDGE CAP 	RRCP	10'2"	17"
FORMED RIDGECAP 	FRCP(color) FRCP(color)+	Panel Loc Panel Loc Plus	3' NA
			Specify pitch up to 4:12
RAKE & CORNER 	COR(color)10	10'0"	13"
	COR(color)12	12'0"	
	COR(color)14	14'0"	
	COR(color)16	16'0"	
	COR(color)18	18'0"	
	COR(color)20	20'0"	
MINI CORNER 	MCRN(color)10	10'2"	9.5"
	MCRN(color)12	12'2"	
	MCRN(color)14	14'2"	
	MCRN(color)16	16'2"	
	29 GAUGE LONG TRIM (Available in Michigan City plant only.)		
	MCRN9(color)12	12'2"	
	MCRN9(color)14	14'2"	
	MCRN9(color)16	16'2"	
GABLE TRIM 	GT6(color)	10'2"	16.5"
J-TRIM 	JT(color)	10'2"	4.81"

TRIMS

Part Number

Length

Girth

RAT GUARD

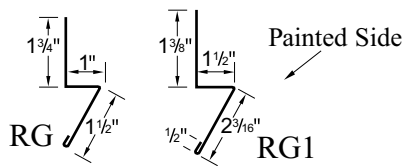

RG(color)
RG1(color)

10'2"
10'2"

4.75"
5.5625"

VALLEY

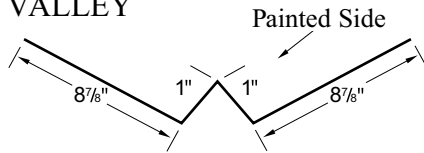

VT1(color)

10'2"

19.75"

GAMBREL TRIM

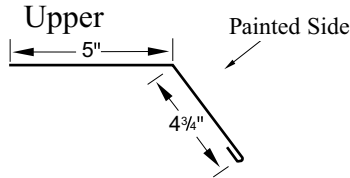

GTU(color)

10'2"

10.25"

specify pitch

GAMBREL TRIM

Lower

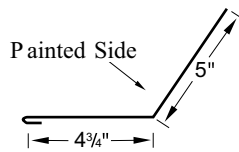

GTL(color)

10'2"

10.25"

specify pitch

SINGLE ANGLE

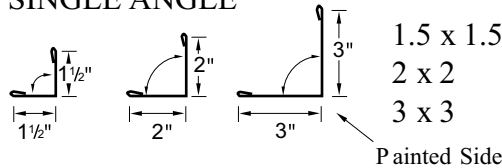

1.5 x 1.5
2 x 2
3 x 3

SA(color)112
SA(color)2X2
SA(color)3X3

10'2"
10'2"
10'2"

4"
5"
7"

INSIDE ANGLE

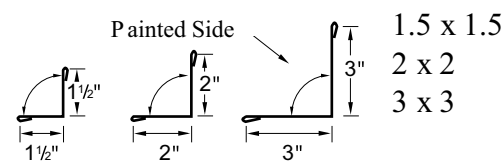

1.5 x 1.5
2 x 2
3 x 3

IA(color)112
IA(color)2X2
IA(color)3X3

10'2"
10'2"
10'2"

4"
5"
7"

POST TRIM

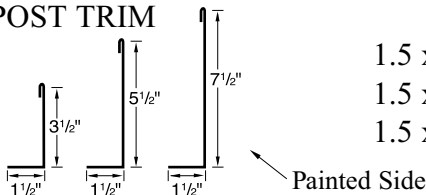

1.5 x 3.5
1.5 x 5.5
1.5 x 7.5

SA(color)312
SA(color)512
SA(color)712

10'2"
10'2"
10'2"

5.5"
7.5"
9.5"

UNIVERSAL SIDEWALL

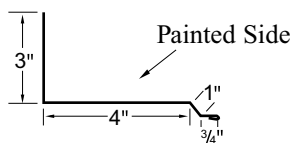

SF1(color)

10'2"

9.25"

UNIVERSAL ENDWALL

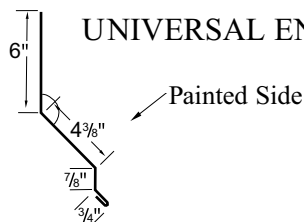

EF(color)

10'2"

12.5"

specify pitch

TRIMS

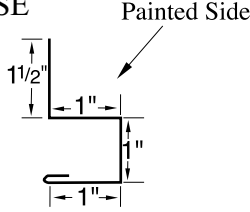
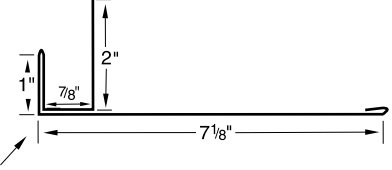
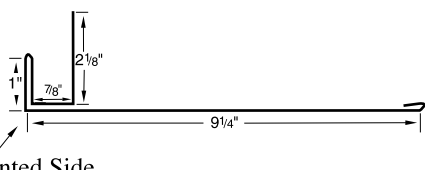
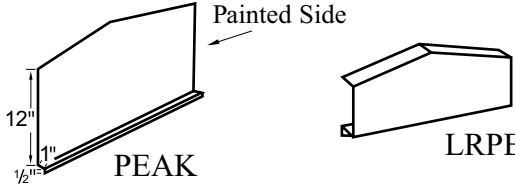
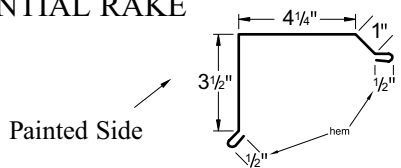
	Part Number	Length	Girth
<p>SQUARE BASE</p> 	SBA(color)	10'2"	5"
<p>OVERHEAD DOOR JAMB</p> 	OHDJ(color) OHDJ12(color) OHDJ14(color) OHDJ16(color)	10'2" 12'2" 14'2" 16'2"	12.5"
<p>OVERHEAD DOOR JAMB 9 1/4"</p> 	OHDJ9(color) OHDJ916(color)	10'2" 16'2"*	14.75" *Offered out of Michigan City location. Longer lead times may apply.
<p>PEAK PLATE</p> 	PEAK(color) LRPBOXF	3' Standard 4:12	NA
<p>RESIDENTIAL RAKE</p> 	RRT(color)	10'2"	10.75"

TRIMS

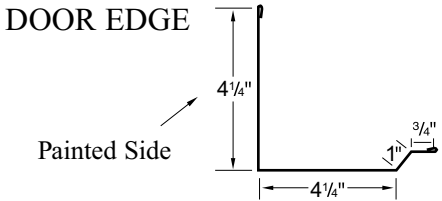
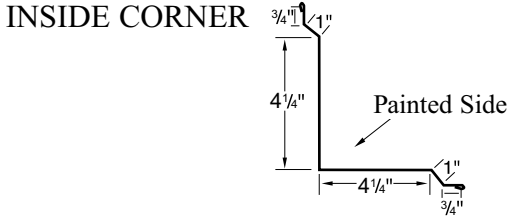
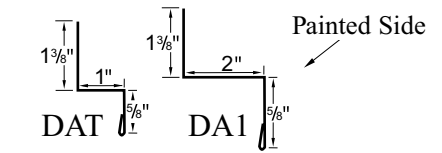
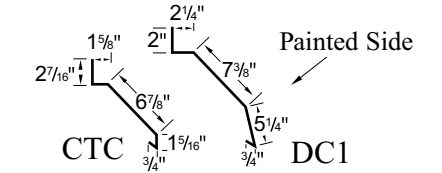
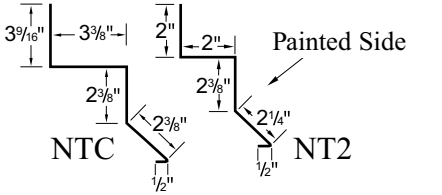
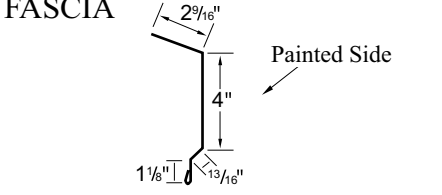
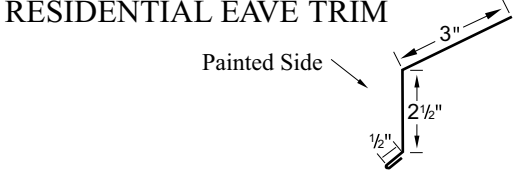
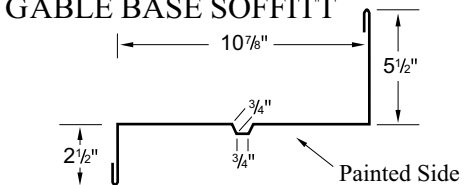
	Part Number	Length	Girth
DOOR EDGE 	DJ10(color)	10'2"	11.25"
INSIDE CORNER 	IC1(color)	10'2"	13"
DOUBLE ANGLE 	DAT(color) DA1(color)	10'2" 10'2"	3.5" 4.5"
ROUND TRACK COVER 	CTC(color) DC1(color)	10'2" 10'2"	13" 17.625"
SQUARE TRACK COVER-NATL 	NTC(color)* NT2(color)*	10'2" 10'2"	12.19" 9.125"
*hardware not available			
FASCIA 	FT(color)	10'2"	9" specify pitch
RESIDENTIAL EAVE TRIM 	RET(color)	10'2"	6.5" specify pitch
GABLE BASE SOFFITT 	GB1(color)	10'2"	20.25"

TRIMS

Part Number

Length

Girth

WINDOW DRIP CAP

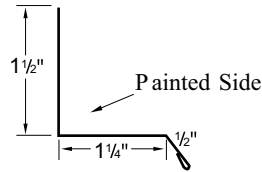

WC(color)

10'2"

3.75"

RESIDENTIAL DRIP EDGE

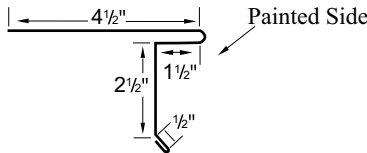

RDC(color)

10'2"

9.5"

Default is 90°
as shown
Specify pitch
6:12 or less

DOOR POST TRIM

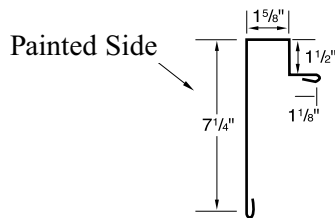

DJ8(color)

10'2"

12.5"

FLAT SHEETS*

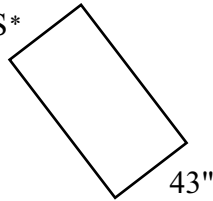

(color)CQ

10'2"

NA

*There will be an additional
pallet charge for flat sheets

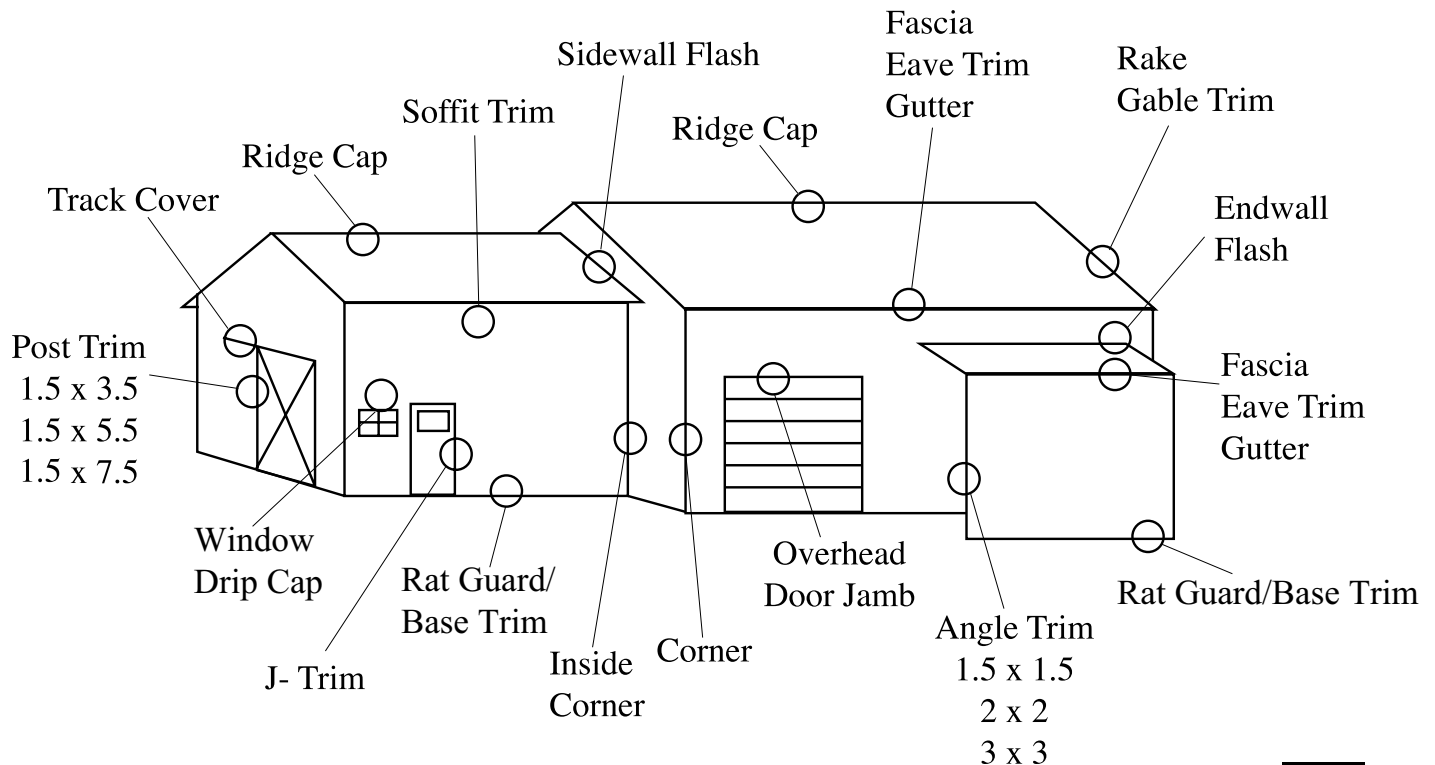

SOFFIT

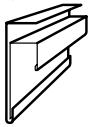
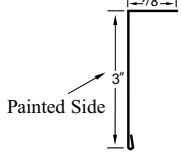
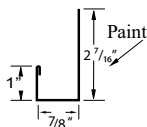
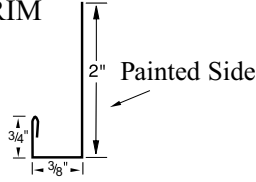
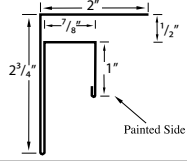
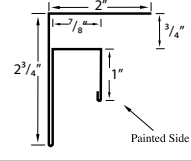
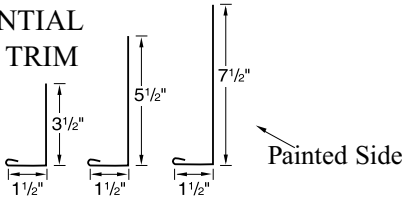
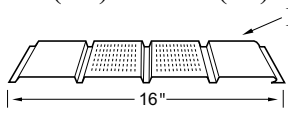
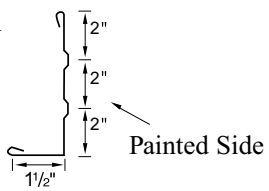
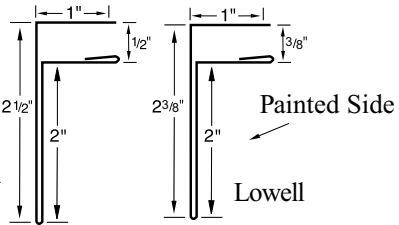

		Part Number	Length	Girth	
F&J ASSEMBLY (SFA & JT) 	SOFFIT F ADAPTOR 	J-TRIM 	SFA	10'2"	4.375"
			JT(color)	10'2"	4.81"
SOFFIT J-TRIM 		SJT(color)	10'2"	3.625"	
SOFFIT F&J 	PANEL LOC PLUS F&J 	SFJ(color)	10'2"	9.375"	
		PFJ(color)	10'2"	9.125"	
RESIDENTIAL FASCIA TRIM 	RFT 312	10'2"	5.5"		
	RFT 512	10'2"	7.5"		
	RFT 712	10'2"	9.5"		
ALUMINUM SOFFIT Vented (VS) or Solid (SS) 		VS(color)12	12'2"	NA	
		SS(color)12	12'2"		
BEADED FASCIA 		BFT(color)	10'2"	8.25"	
F CHANNEL * 	Michigan City	FC(color)	10'2"	6.875"	
	Lowell				

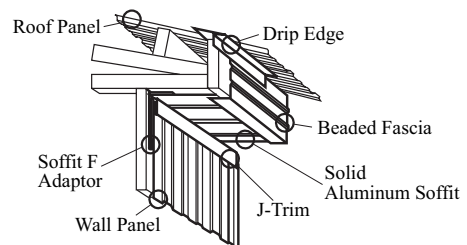
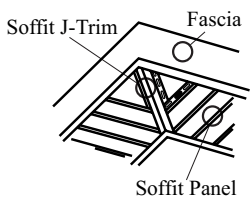
*Varies by plant location; please call your salesperson to verify availability.

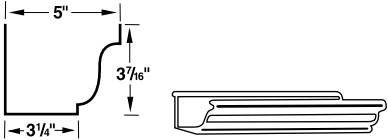
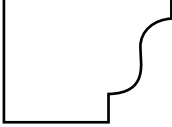
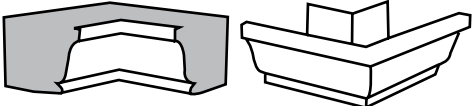
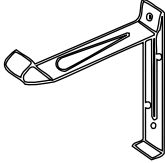
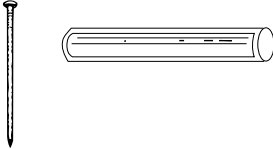
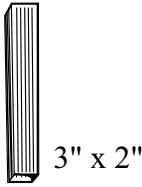

GUTTERS

(Gutters not available in Gold, Bare Metal, Hawaiian Blue or Polar White)

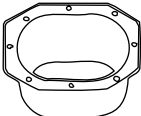
	Part Number	Length
GUTTER 	K5G206(color)	20'6"
GUTTER END CAP  <p>Left hand shown</p>	K5GECR(color) K5GECL(color)	Right Left Specify right or left hand
CORNER BOXES  <p>Inside Outside</p>	K5GISQCR Inside K5GOSQCR Outside	White Only
CONCEALED FASCIA BRACKET 	K5GCFZ	sold separately or Qty: 100 per box
SPIKES & FERRULES 	K5GS8 K5GF5	8" Spike sold separately or Qty: 50 lbs. per box 5" Ferrule sold separately or Qty: 500 per box
DOWNSPOUT  <p>3" x 2"</p>	K5GDS10(color)	10'0" sold separately or Qty: 15 per box
DOWNSPOUT STRAP 	K5GSCB(color)	sold separately or Qty: 100 per box
DOWNSPOUT ELBOW  <p>75°</p>	K5GEA(color)	sold separately or Qty: 20 per box
OVAL OUTLET w/ Flange 	K5GOOFZ	sold separately or Qty: 20 per box

K5 Gutter

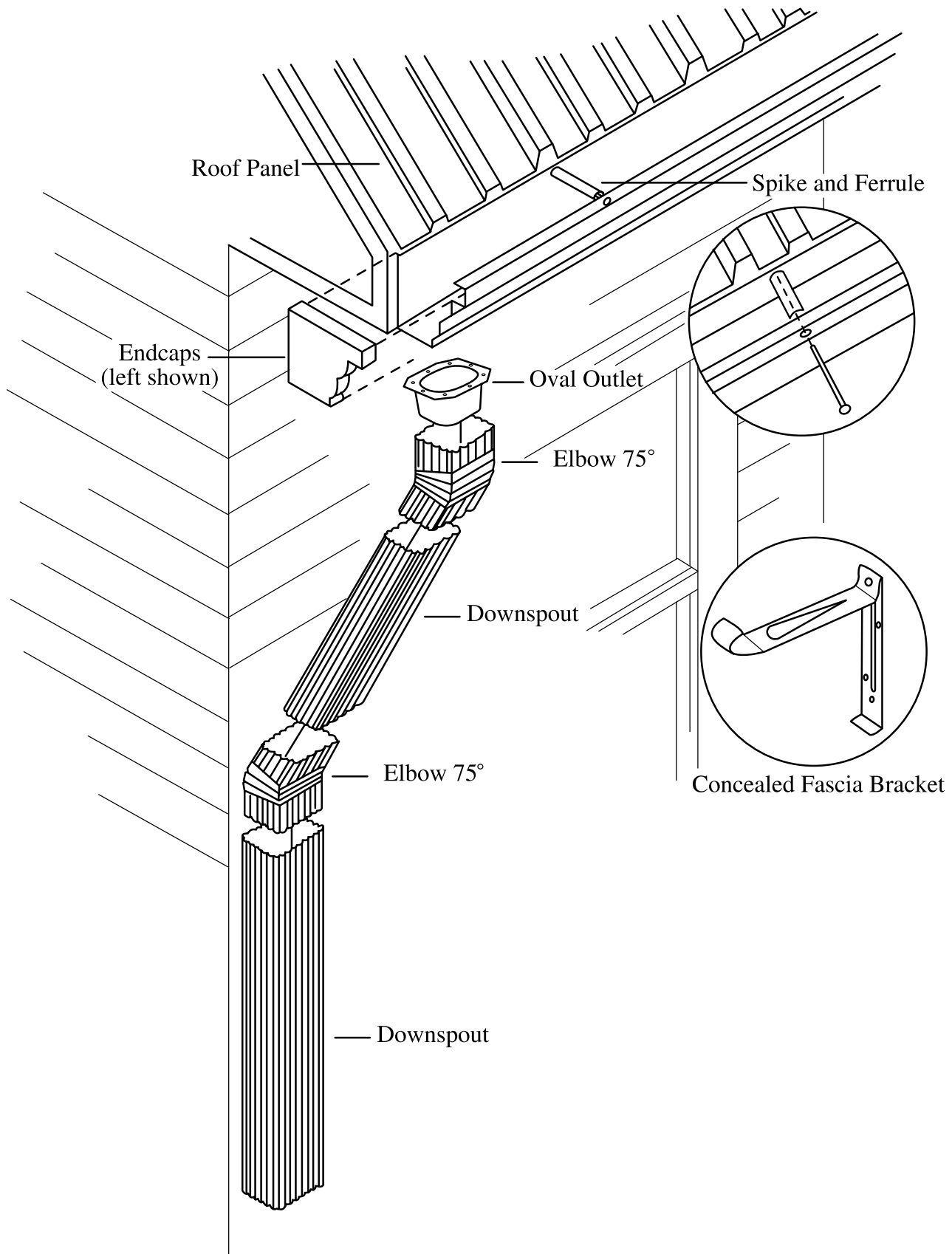

ACCESSORIES

	Part Number	Color	Length	SqFt Weight
--	-------------	-------	--------	-------------

FIBERGLASS SKYLIGHTS

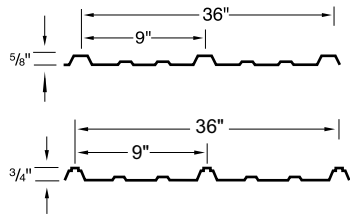

SKY8 (+)	White	8'	5oz
SKY10 (+)	White	10'	5oz
SKY12 (+)	White	12'	5oz

POLYCARBONATE SKYLIGHTS

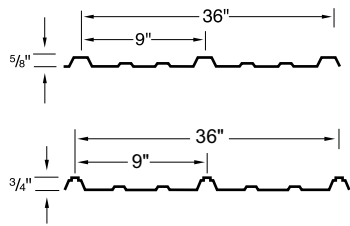

SKYPCW8 (+) *			
SKYPCC8 + (Panel Loc Plus Only)			
SKYPCW10 (+) *			
SKYPCC10 + (Panel Loc Plus Only)			
SKYPCW12(+)*			
SKYPCC12 + (Panel Loc Plus Only)			

CONTINUOUS RIDGE VENT

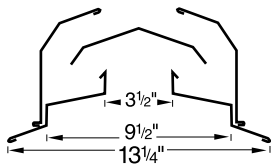

RLW	White	10'
-----	-------	-----

CLOSURE VENT

Closure is 1 3/8" tall, may require longer screw for installation.



CLV+ (Panel Loc Plus)	3'	Available at Jasper, Cedar Hill and Michigan City
CLV+M (Panel Loc Plus) (Marco)	3'	Available at Lowell

Item may vary from sample shown. Contact sales rep for more information

Qty: 50 per box

	Part Number	Size	
MASTER PIPE FLASHING			
	MPF	1/4" to 4"	
	MPF2	1 1/4" to 3"	
	MPF4	3" to 6"	
	MPF6	5" to 9"	
	MPF7	6" to 11"	Maximum temperature
	MPF8	7" to 13"	250 degrees
	4SMPF*	3" to 6"	
	6SMPF*	5" to 9"	
8SMPF*	7" to 13"	Maximum temperature	
10SMPF*	13" to 26"	500 degrees	

MASTER PIPE FLASHING WITH ZIPPER

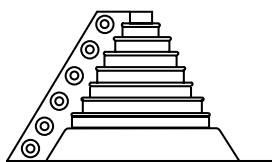

MPF1ZIP*	1/2" - 4" with zipper
MPF2ZIP*	4 1/2" - 9" with zipper

*Not available in all locations. Contact sales rep for lead times.

ACCESSORIES

Part Number Length Color # per Bag # per Box

METAL/WOOD
SCREWS #10

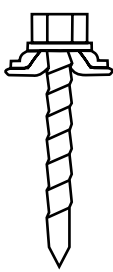

1/4" head	1(color)MW	1"	All	250pc	3000pc
	1 1/2(color)MW	1 1/2"	All	250pc	2500pc
	2(color)MW	2"	All	250pc	2000pc
	2 1/2(color)MW	2 1/2"	All except gold	250pc	1500pc
	3(color)MW	3"	All except gold	250pc	1000pc

Per bag or per box quantities only
Minimum quantity 1 bag

Part Number Length Color # per Bag # per Box

STITCH SCREWS



1/4" head	34(color)ST	3/4"	All	250pc	3000pc
-----------	-------------	------	-----	-------	--------

Per bag or per box quantities only
Minimum quantity 1 bag

METAL/
METAL SCREW #12



5/16" head	34(color)MM	3/4"	All	250pc	2500pc
	114(color)MM	1 1/4"	All	250pc	2500pc
	112(color)MM	1 1/2"	White, Brilliant, Stone, Bare, Green	250pc	2500pc

Per bag or per box quantities only
Minimum quantity 1 bag

LAP SCREWS





5/16" head	78(color)LAP	7/8"	All	250pc	2500pc
------------	--------------	------	-----	-------	--------

Per bag or per box quantities only
Minimum quantity 1 bag

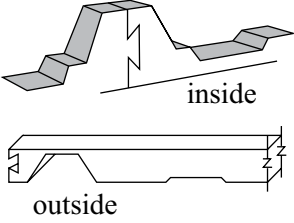
ACCESSORIES

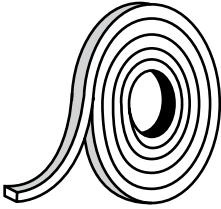
	Part Number	Length
CLOSURES		
(INSIDE or OUTSIDE)		
	CLOUT	Panel Loc outside (no adhesive) 3'
	CLOUT+	Panel Loc Plus outside(no adhesive) 3'
	CLIN	Panel Loc inside (no adhesive) 3'
	CLIN+	Panel Loc Plus inside (no adhesive) 3'
	CLOUTWGLUE	Panel Loc outside (with adhesive) 3'
	CLOUT+GLUE	Panel Loc Plus outside (with adhesive) 3'
	CLINWGLUE	Panel Loc inside (with adhesive) 3'
	CLIN+GLUE	Panel Loc Plus inside (with adhesive) 3'
100 per box		

	Part Number	Length	Size
UNIVERSAL POLYFOAM			
	POLY	25'	1"x1 1/2"
	20 rolls per bag		

	Part Number	Length	Width	Thickness
GRAYFLEX				
Joint Seal Tape 	GRAYFLEX-6	20'	1"	1" **
	10 rolls per box **Expanded size			

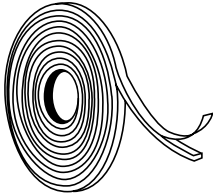
	Part Number	Length	Width	Thickness
BUTYL TAPE				
	BT	40'	1/4"	3/16"
	BTR	40'	7/8"	3/16"
BT 20 rolls per box BTR 10 rolls per box				

ACCESSORIES

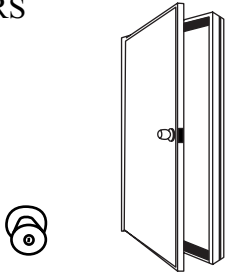
	Part Number	Size	Overall Dimension
	3068DR* (Steel Jamb)	3068	39 13/16" x 80 5/8"
	4068DR* (Aluminum Jamb)	4068	49 13/16" x 80 5/8"
	KNOB		

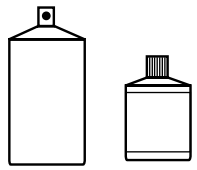
TOUCH UP PAINT			
	4(color)SP	0.6oz bottle with brush	
	4ZZSP*	4.5oz spray can (backer paint)	
	12PURSP*	12oz spray can (purlin paint)	

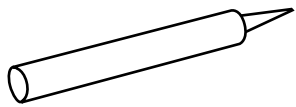
GEOCEL-TRIPOLYMER SEALANT			
	GEO(color)	10.6 oz. tube	clear, gray, white
		Qty: 24 per box	
<p>Note: Color caulking available in certain colors in Lowell. Contact salesperson for details.</p>			

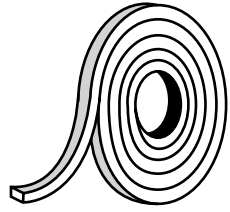
RETRO-EASE			
	RETROEASE	300ft. roll	

WINDOWS				
	WD3X3*	3x3		
	WD3X2*	3x2		
slider w/ screen non-insulated				
	Part Number	Length	Width	Thickness

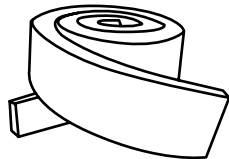
FLEXOVENT				
	FLEXOVENT	10'	3"	1 1/2"
		Qty: 2 10' rolls per box		

*Longer lead times in Michigan City. Contact sales person for details.

SLIDING DOORS

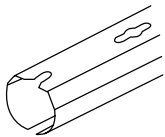
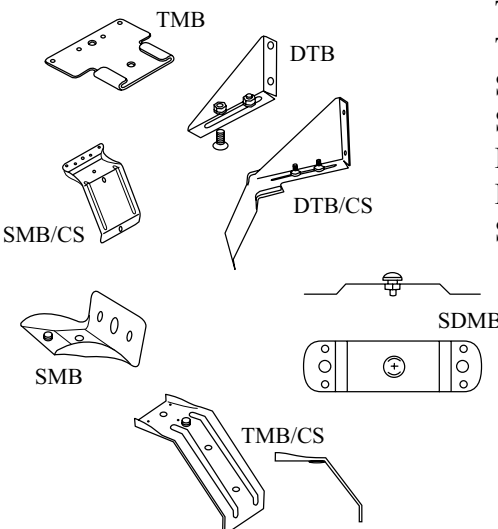
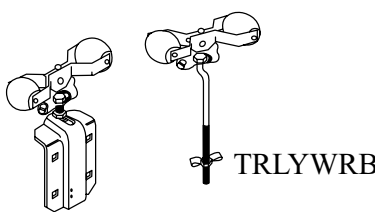
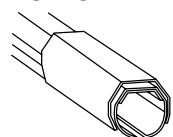
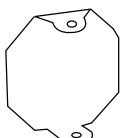
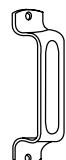
	Part Number	Length
SLOTTED TRACK		
	8STRK	8'
	10STRK	10'
	12STRK	12'
TRACK MOUNTING BRACKETS		
	TMB	Top Mount Bracket
	TMB/CS	Top Mount Bracket w/Cover Support
	SMB	Side Mount Bracket
	SMB/CS	Side Mount Bracket w/ Cover Support
	DTB	Double Track Bracket
	DTB/CS	Double Track Bracket w/Cover Support
	SDMB	Stud Mount Bracket
TROLLEYS		
	DSRLLRWRB	Plate Trolley w/ Roller Bearing (includes endcaps)
	TRLYWRB	9.5" Bolt w/ Roller Bearing
		Qty: 2 per bag
SPLICE CLIP		
	SPLCLP	
TRACK END CAP		
	ENDCAP	
DOOR PULL		
White	DRPUL	Available in white only
		

NOTE: Illustrations may not match actual parts. Contact salesperson for details.

SLIDING DOORS

Part Number

DOOR STOPS

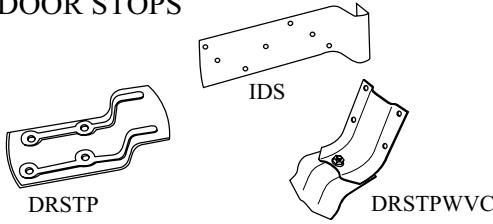

IDS	Inside Door Stop
DRSTP	Heavy Duty Stop
DRSTPWVC	Adjustable Stop

DOOR LOCKS

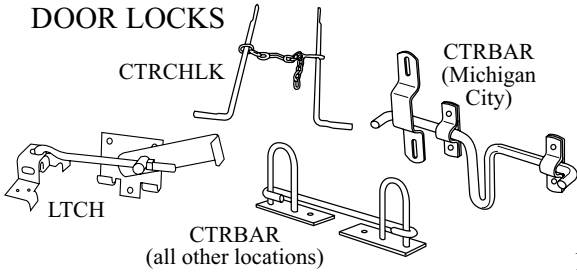

LTCH	Jamb Latch (Cam Latch)
CTRCHLK	Center Chain Lock
CTRBAR	Center Bar Lock

NOTE: Illustrations may not match actual parts. Contact salesperson for details.

ALUMINUM VERTICAL RAILS

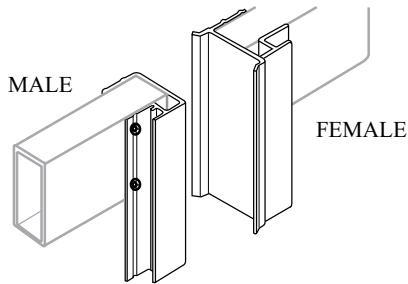

Part Number	Length
10VTRTL	10'AV Male
12VTRTL	12'AV Male
14VTRTL	14'AV Male
16VTRTL	16'AV Male
10VRTWH	10'HV Female
12VRTWH	12'HV Female
14VRTWH	14'HV Female
16VRTWH	16'HV Female

BOX GIRTS

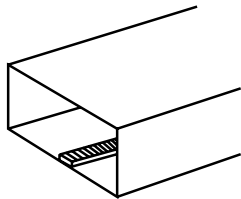

BOXGIRT8	8'
BOXGIRT10	10'
BOXGIRT12	12'
BOXGIRT14	14'
BOXGIRT16	16'

SLIDING DOORS

HEAVY DUTY
STAY ROLLER⁺⁺

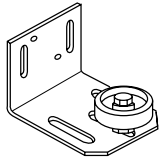

Part Number

STYRLLR

Part Number

Length

ALUMINUM BOTTOM RAIL
FOR STAYROLLER⁺⁺

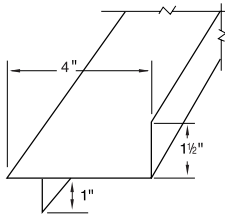

ABRL12

12'

⁺⁺ These 2 components are designed to go together as a guide system.

Part Number

Length

CENTER DOOR GUIDE*

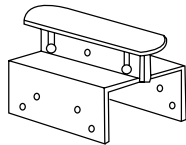

CGWHD

ALUMINUM BOTTOM RAIL
FOR GUIDE*

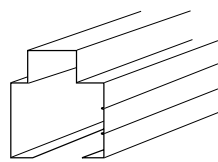

8BRL

8'

10BRL

10'

12BRL

12'

14BRL

14'

16BRL

16'

BOTTOM GUIDE RAIL*

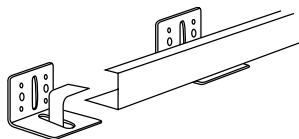

6BGRL

6'

8BGRL

8'

10BGRL

10'

*These 3 components are designed to go together as a guide system.

SLIDING DOORS

- 1) Slotted Track
- 2) End Cap
- 3) Track Mount Bracket for Track & Cover
- 4) Trolley
- 5) Splice Clip
- 6) Door Pull
- 7) Stay Roller
- 8) Door Stop

